

Marshall

WOBURN II BLUETOOTH

USER MANUAL

LEGAL & TRADEMARK NOTICE

- Design of device and packaging are intellectual properties of Zound Industries International AB and Marshall Amplification Plc. © All Rights Reserved. Zound Industries International AB is hereinafter referred to as “Zound Industries” or “manufacturer”.
- MARSHALL, Marshall Amps, their respective logos, “Marshall” and “Marshall” trade dress are trademarks and intellectual property of Marshall Amplification Plc and may not be used without permission. Permission granted to Zound Industries.
- Qualcomm aptX is a product of Qualcomm Technologies International, Ltd. Qualcomm is a trademark of Qualcomm Incorporated, registered in the United States and other countries, used with permission. aptX is a trademark of Qualcomm Technologies International, Ltd., registered in the United States and other countries, used with permission.
- The Bluetooth® wordmark and logos are registered trademarks owned by the Bluetooth SIG, Inc. and any use of such marks by Zound Industries is under license.
- Apple and the Apple logo are trademarks of Apple Inc., registered in the U.S. and other countries. App Store is a service mark of Apple Inc., registered in the U.S. and other countries.
- Google Play and the Google Play logo are trademarks of Google LLC.
- All other trademarks are the property of their respective owners and may not be used without permission.
- For more legal information related to this product and to its use in your specific region, and for more detailed information about Zound Industries and partner & license information, please visit the website: www.marshallheadphones.com. The user is recommended to visit the website regularly for up-to-date information.

Zound Industries International AB, Centralplan 15, 111 20 Stockholm, Sweden

INDEX

ENGLISH

SECTIONS

PAGE

- 002. LEGAL & TRADEMARK NOTICE**
- 004. BOX CONTENTS**
- 005. GENERAL DESCRIPTION**
- 007. PLUGGING IN THE WOBURN II**
- 008. TURNING THE WOBURN II ON/OFF**
- 009. SETTING UP THE WOBURN II**
- 010. SELECTING AUDIO SOURCE**
- 011. CONNECTING VIA BLUETOOTH (PAIRING)**
- 012. CONNECTING VIA AUX INPUT**
- 013. CONNECTING VIA RCA INPUT**
- 014. ADJUSTING THE VOLUME/BASS/TREBLE**
- 015. PLAY/PAUSE CONTROL**
- 016. COUPLE SPEAKERS**
- 018. STANDBY MODE**
- 019. TECHNICAL INFORMATION**
- 020. TROUBLESHOOTING**

BOX CONTENTS

- 001. MARSHALL WOBURN II WIRELESS HOME Bluetooth® SPEAKER
- 002. QUICK START GUIDE
- 003. IMPORTANT SAFETY INSTRUCTIONS
- 004. MAINS LEAD

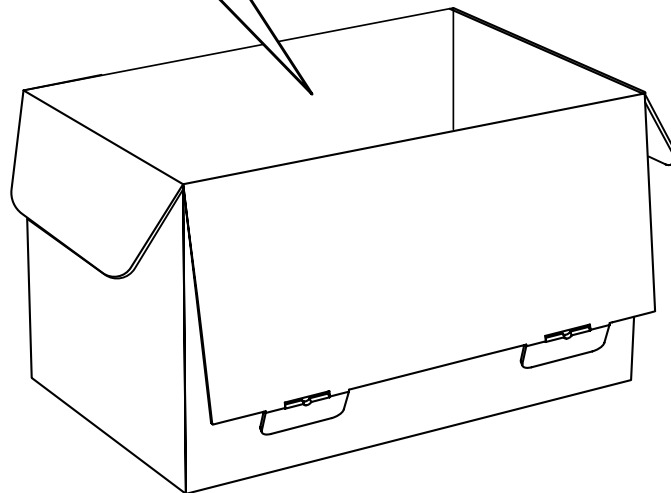
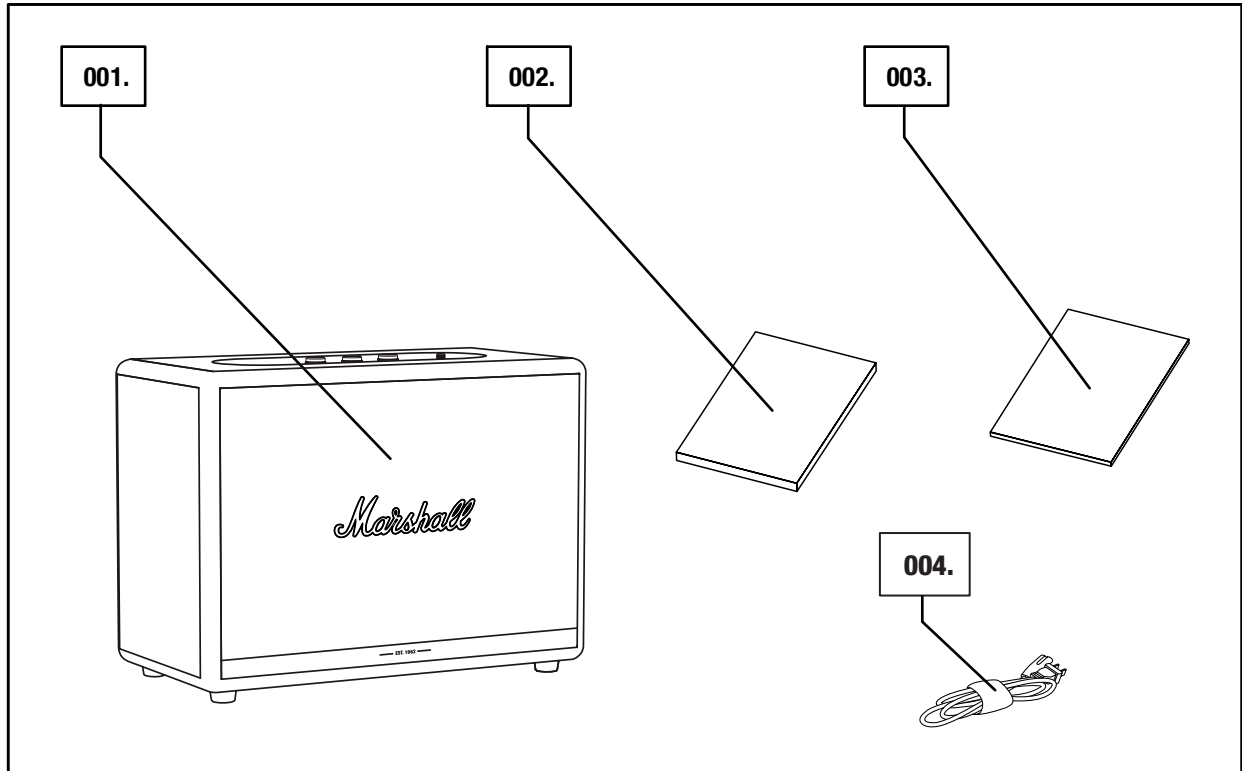

GENERAL DESCRIPTION

- 001. AUX INPUT FOR 3.5 mm JACK
- 002. SOURCE INDICATORS
- 003. SOURCE BUTTON
- 004. VOLUME KNOB
- 005. BASS KNOB
- 006. TREBLE KNOB
- 007. PLAY/PAUSE BUTTON
- 008. POWER LEVER

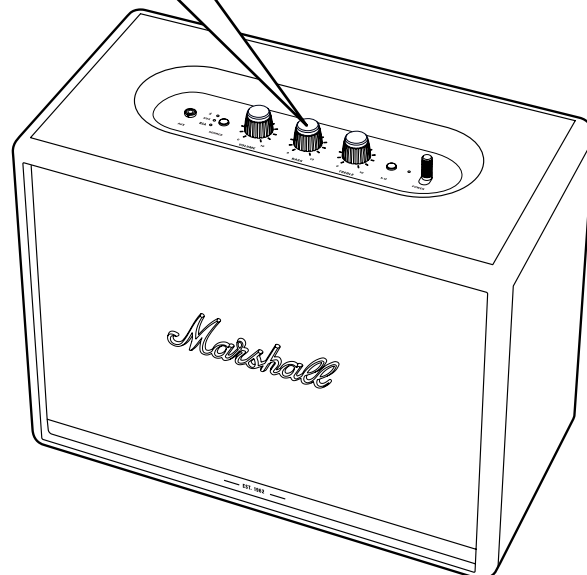
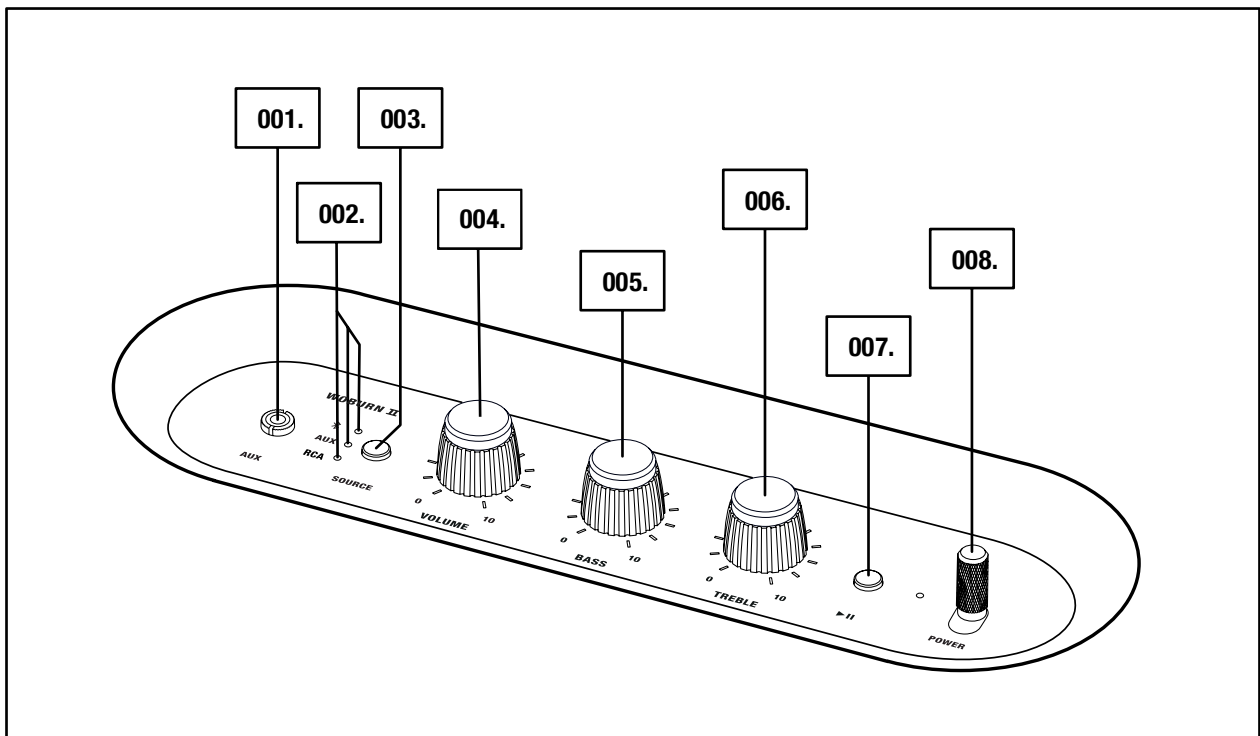

005.

Marshall

GENERAL DESCRIPTION CONTINUED

- 009. BASS PORT
- 010. BACKPLATE
- 011. RCA INPUT (LEFT AND RIGHT)
- 012. MAINS INPUT
- 013. MAINS LEAD

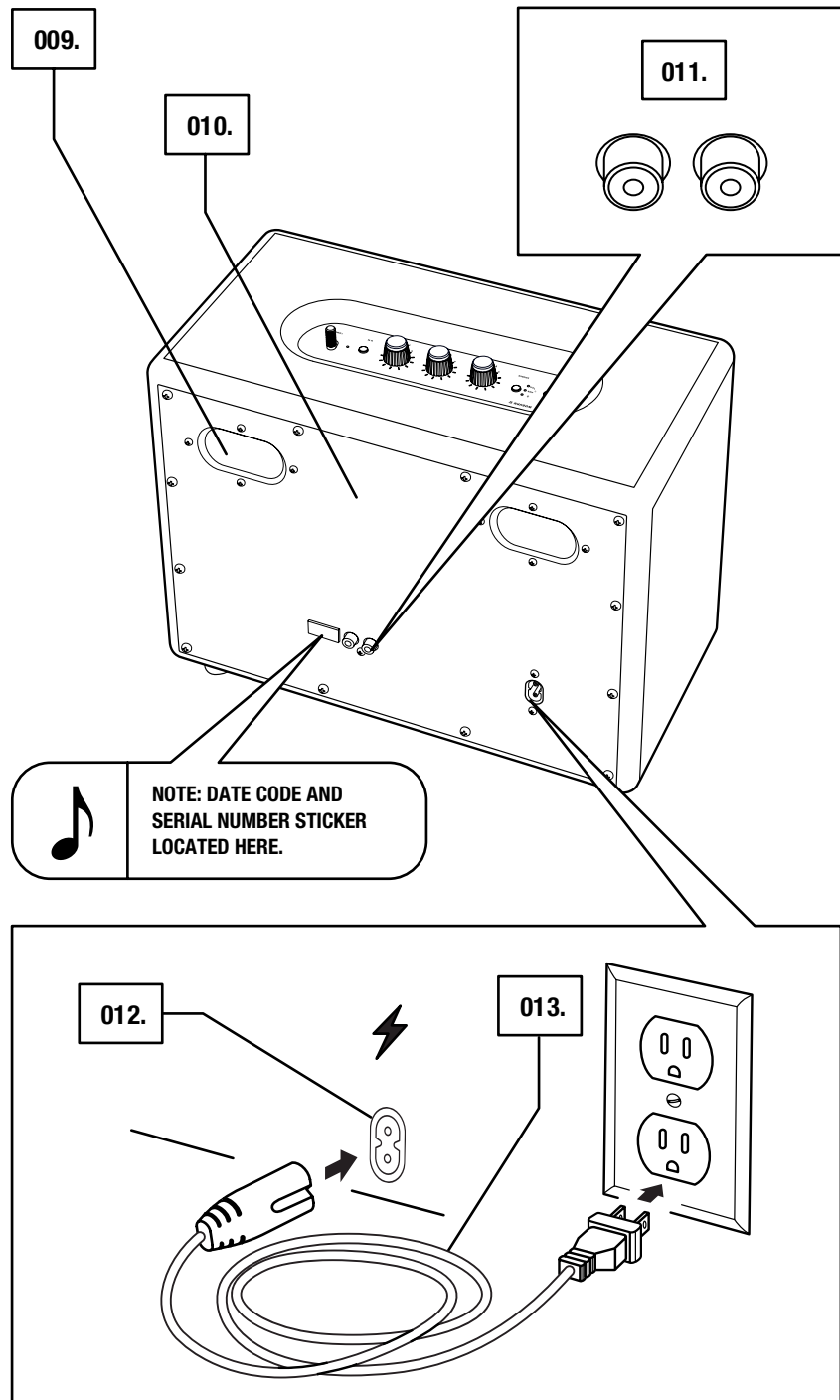

PLUGGING IN THE WOBURN II

IMPORTANT: ALWAYS ENSURE THAT THE MAINS LEAD, POWER JACK AND SPEAKER ARE COMPATIBLE WITH YOUR MAINS SUPPLY AND WALL SOCKET.

- 001. CONNECT THE MAINS LEAD INTO THE MAINS INPUT ON THE SPEAKER.**
- 002. CONNECT THE POWER JACK TO THE WALL SOCKET.**



CAUTION: ALWAYS UNPLUG THE MAINS LEAD FROM THE WALL SOCKET BEFORE DISCONNECTING IT FROM THE SPEAKER.

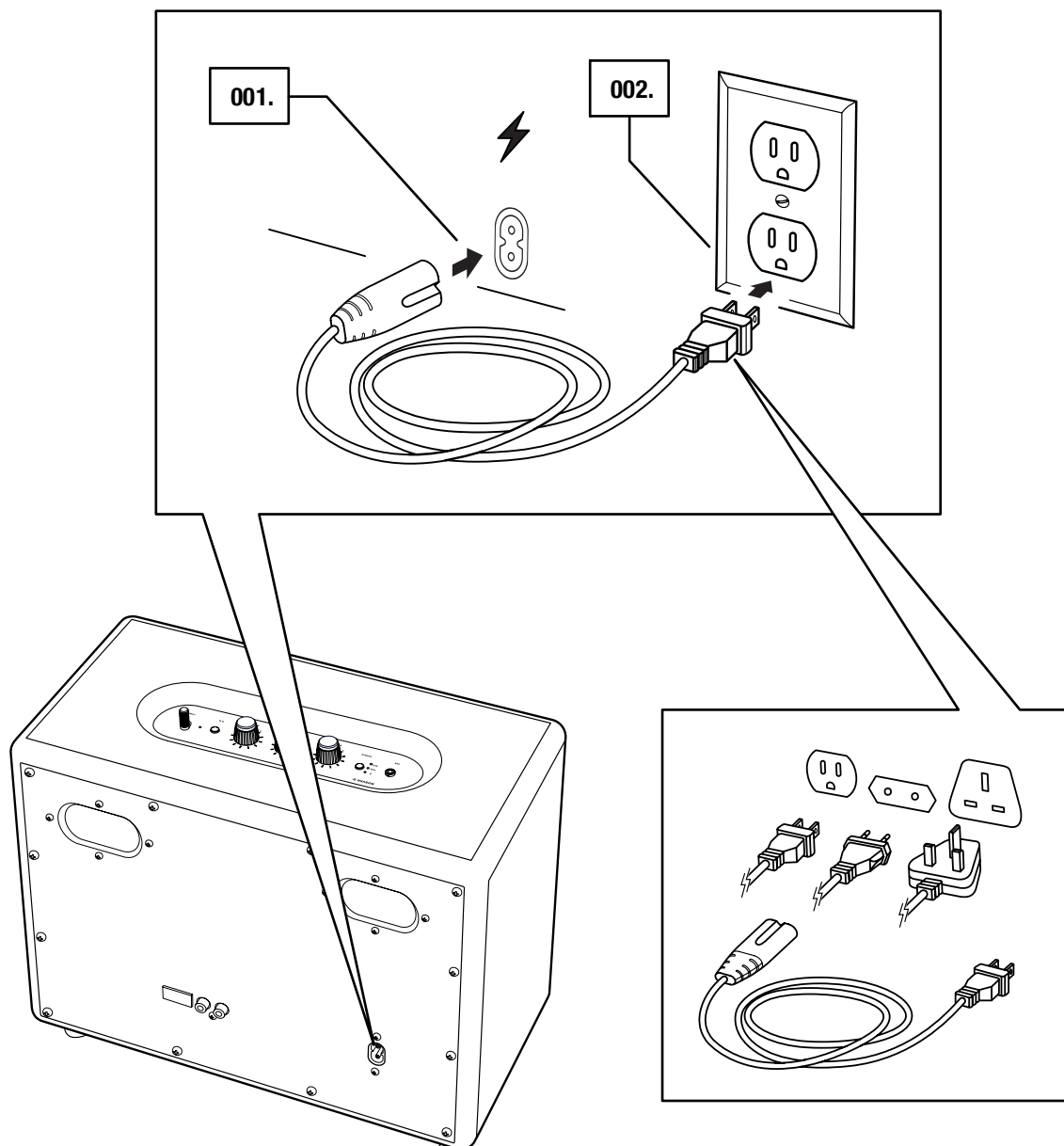

TURNING THE WOBURN II ON/OFF

001. ON: PULL AND HOLD THE **POWER LEVER** TOWARDS THE FRONT OF THE SPEAKER UNTIL THE POWER ON SOUND PLAYS AND THE INDICATORS LIGHT UP.
002. OFF: PULL AND HOLD THE **POWER LEVER** TOWARDS THE FRONT OF THE SPEAKER UNTIL THE POWER OFF SOUND PLAYS AND ALL INDICATORS TURN OFF.

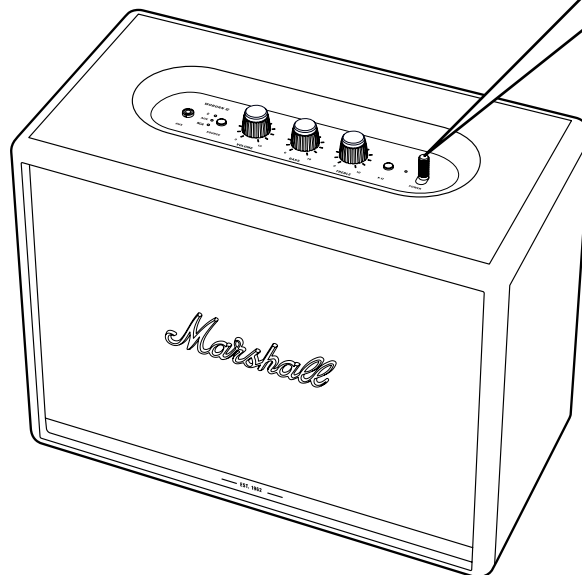
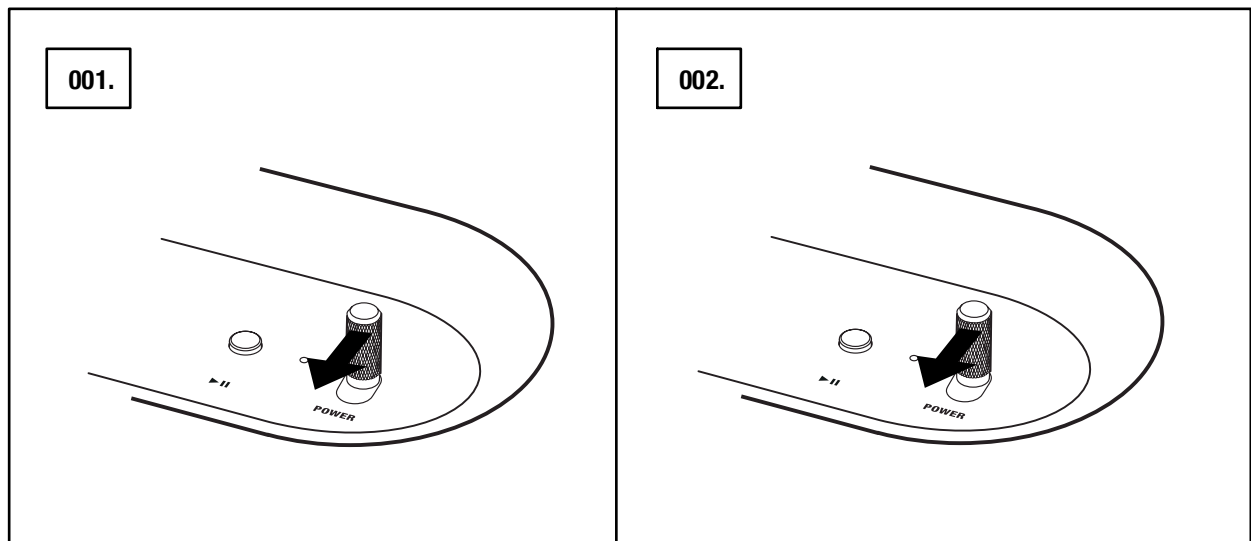

SETTING UP THE WOBURN II

CONFIGURE THE SPEAKER WITH THE **MARSHALL BLUETOOTH®** APP TO GET THE MOST OUT OF IT. THE APP IS AVAILABLE FROM THE APP STORE AND GOOGLE PLAY.

001. DOWNLOAD THE **MARSHALL BLUETOOTH®** APP AND FOLLOW THE IN-APP INSTRUCTIONS.



SELECTING AUDIO SOURCE

THERE ARE MANY WAYS TO CONNECT TO YOUR WOBURN II, EITHER WIRELESSLY OR BY CABLE.

-  - WIRELESS Bluetooth CONNECTION
- AUX - 3.5 mm STEREO JACK
- RCA - DOUBLE RCA (LEFT AND RIGHT) JACKS

001. PUSH THE **SOURCE** BUTTON TO TOGGLE BETWEEN Bluetooth, AUX AND RCA AUDIO SOURCE.

002. A LIT INDICATOR SHOWS WHICH SOURCE IS SELECTED.

THE SOURCE CAN ALSO BE SELECTED FROM THE **MARSHALL BLUETOOTH®** APP.

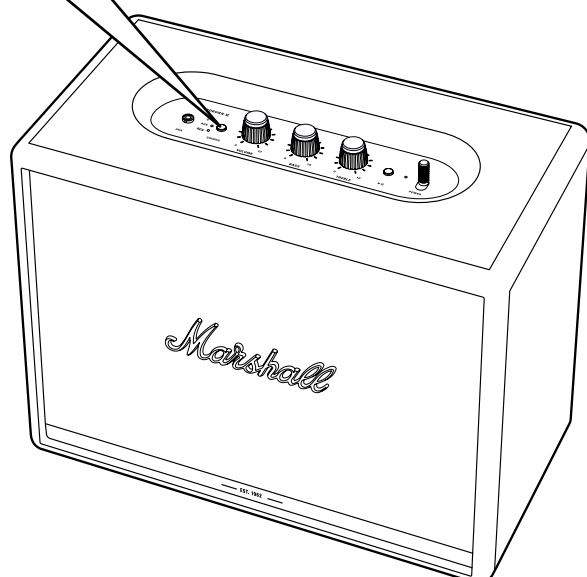
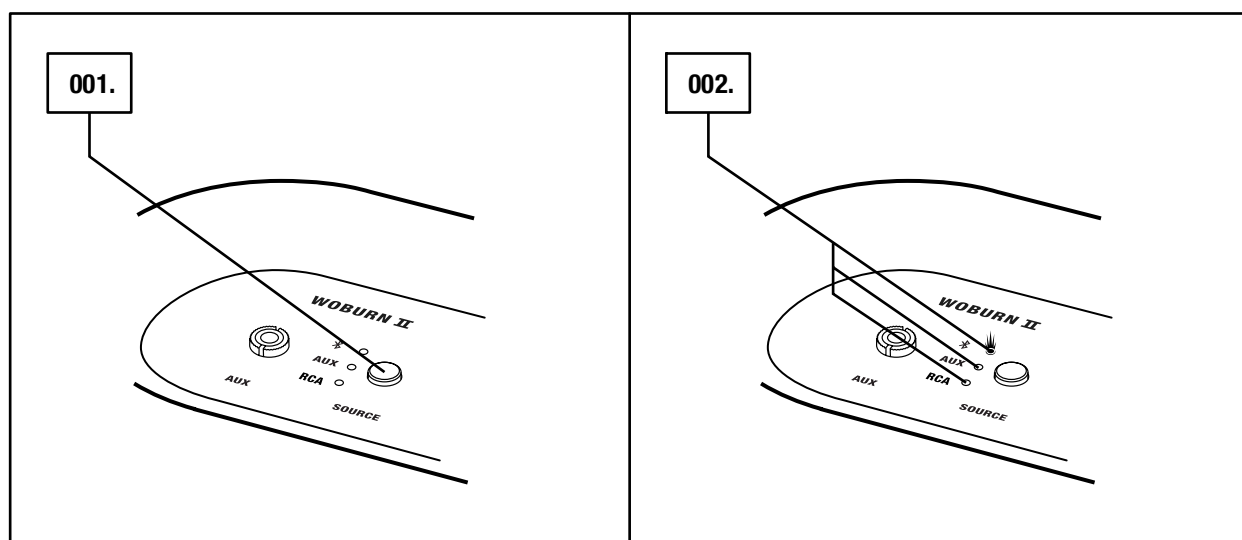

 **CAUTION: MAKE SURE THAT THE VOLUME IS SET TO LOW ON BOTH THE SPEAKER AND THE MUSIC PLAYER BEFORE USING THE SPEAKER.**

CONNECTING VIA Bluetooth (PAIRING)

001. SELECT Bluetooth AS THE INPUT. PUSHING THE **SOURCE** BUTTON TOGGLES THE INPUT SOURCES.
002. PUSH AND HOLD THE **SOURCE** BUTTON FOR 2 SECONDS. THE Bluetooth INDICATOR STARTS TO BLINK.
003. ENABLE Bluetooth ON YOUR DEVICE (SMARTPHONE, TABLET, COMPUTER).
004. SELECT **WOBURN II** FROM THE Bluetooth LIST AND ACCEPT PAIRING. THE Bluetooth INDICATOR ON THE SPEAKER STOPS BLINKING AND REMAINS LIT WHEN THE UNITS ARE CONNECTED.

WOBURN II CAN BE CONNECTED TO TWO Bluetooth DEVICES AT THE SAME TIME. PLAYING A CONNECTED Bluetooth DEVICE WILL MAKE IT THE SELECTED AUDIO SOURCE, PAUSING ANY PREVIOUSLY PLAYED AUDIO ON THE SECOND DEVICE.

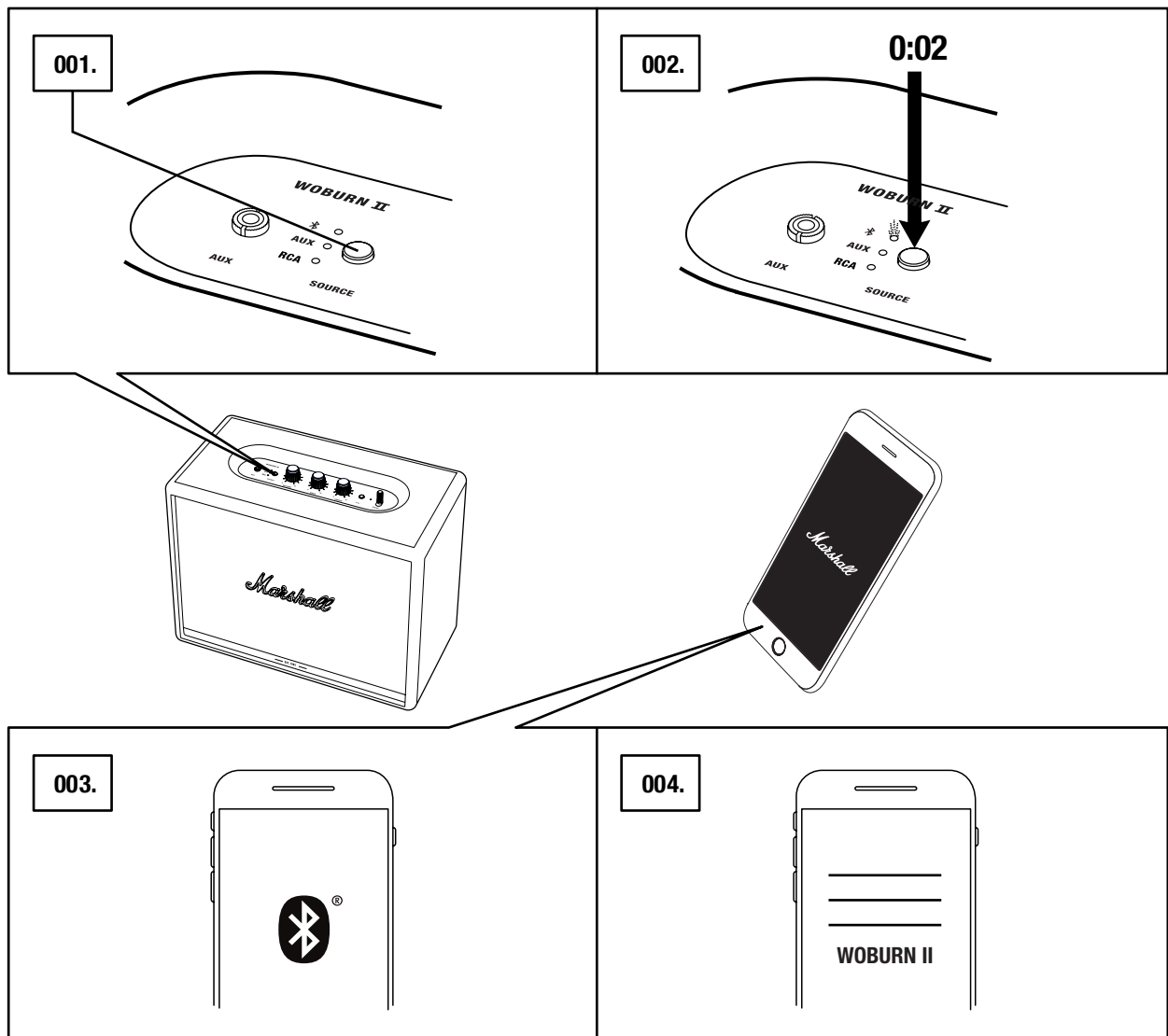

CONNECTING VIA AUX INPUT

001. CONNECT A 3.5 mm STEREO JACK TO THE INPUT LABELLED **AUX** ON THE TOP OF THE SPEAKER.
002. CONNECT THE OTHER END OF THE LEAD TO THE AUDIO OUTPUT ON YOUR AUDIO SOURCE.
003. SELECT AUX AS THE INPUT. PUSHING THE **SOURCE** BUTTON TOGGLES THE INPUT SOURCES.

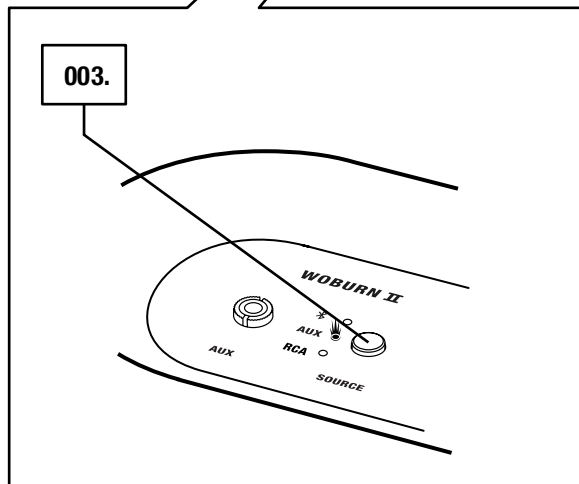
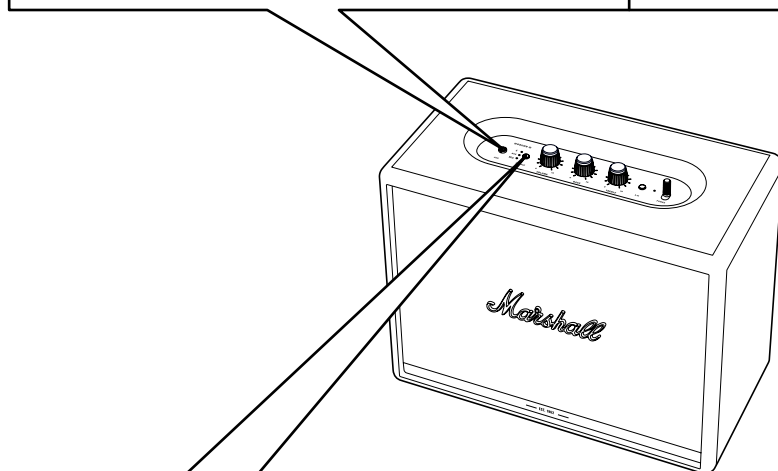
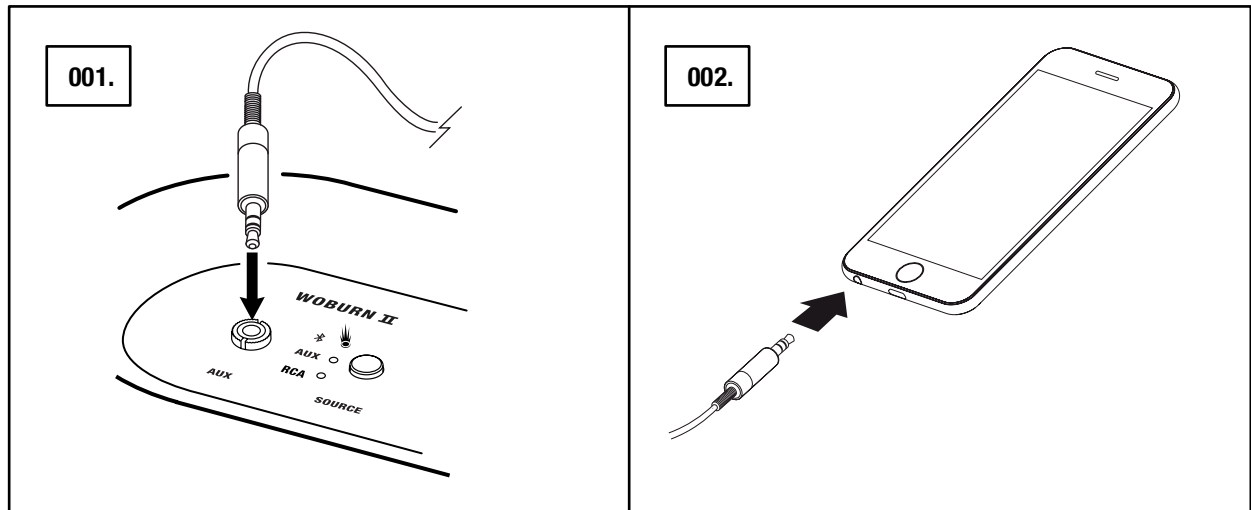

 NOTE: AUDIO LEADS ARE NOT INCLUDED IN THE WOBURN II.

CONNECTING VIA RCA INPUT

001. CONNECT A LEAD WITH RCA JACKS TO THE INPUTS LABELLED **RCA** ON THE BACK OF THE SPEAKER.
002. CONNECT THE OTHER END OF THE LEAD TO THE OUTPUT ON YOUR AUDIO SOURCE.
003. SELECT RCA AS THE INPUT. PUSHING THE **SOURCE** BUTTON TOGGLES THE INPUT SOURCES.

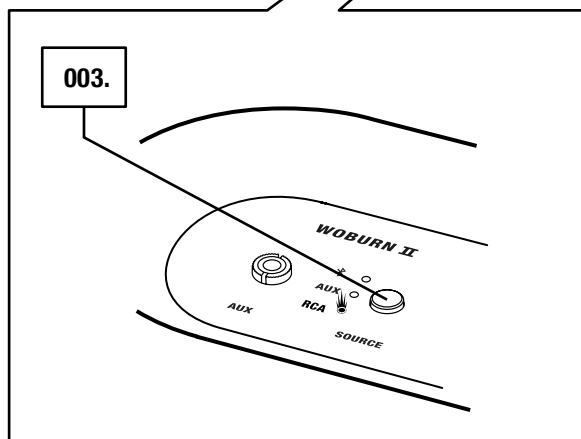
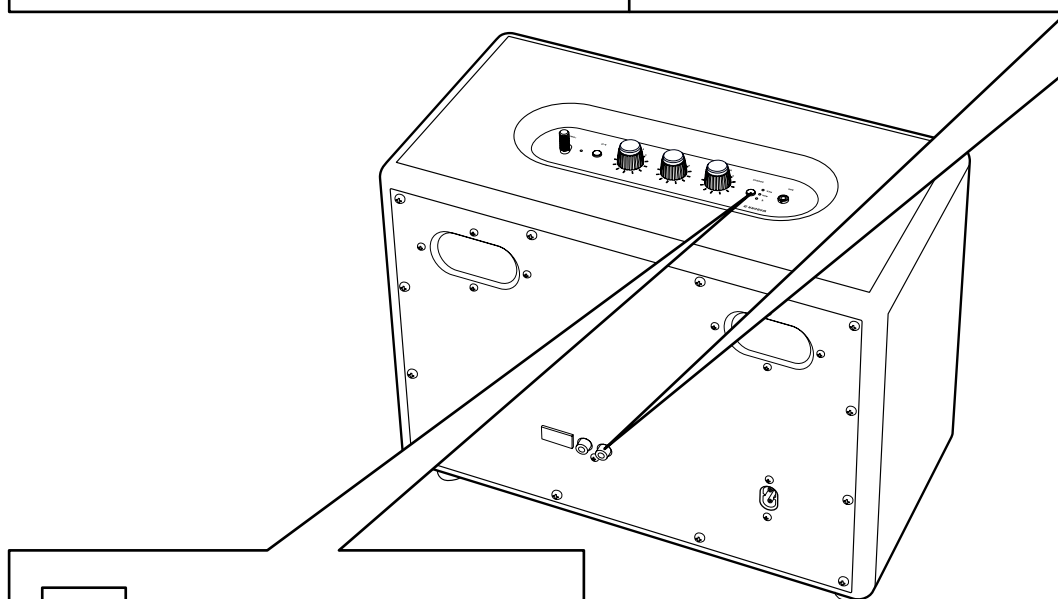
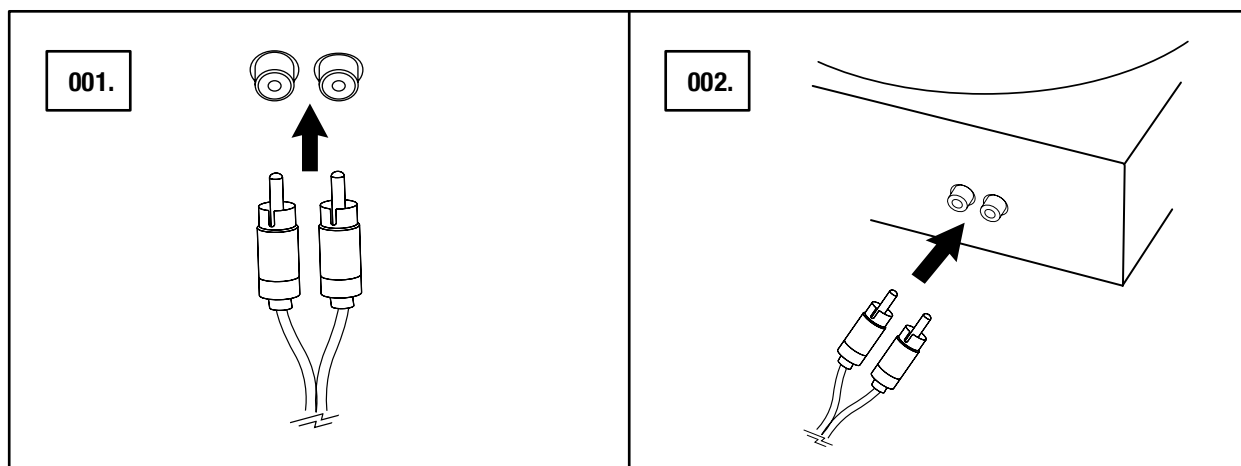

NOTE: A CONNECTED TURNTABLE MUST BE EQUIPPED WITH A RIAA AMPLIFIER OR A SEPARATE PREAMPLIFIER.

ADJUSTING THE VOLUME/BASS/TREBLE

THE WOBURN II INCLUDES THREE KNOBS FOR ADJUSTING THE AUDIO.

001. VOLUME KNOB

002. BASS KNOB

003. TREBLE KNOB

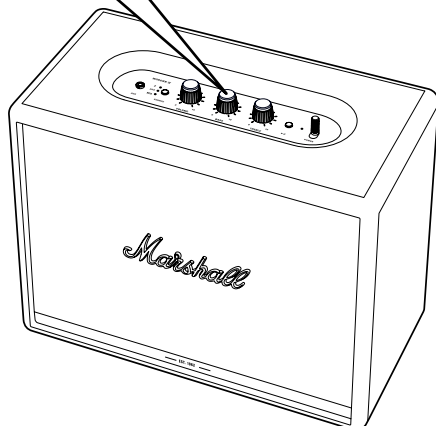
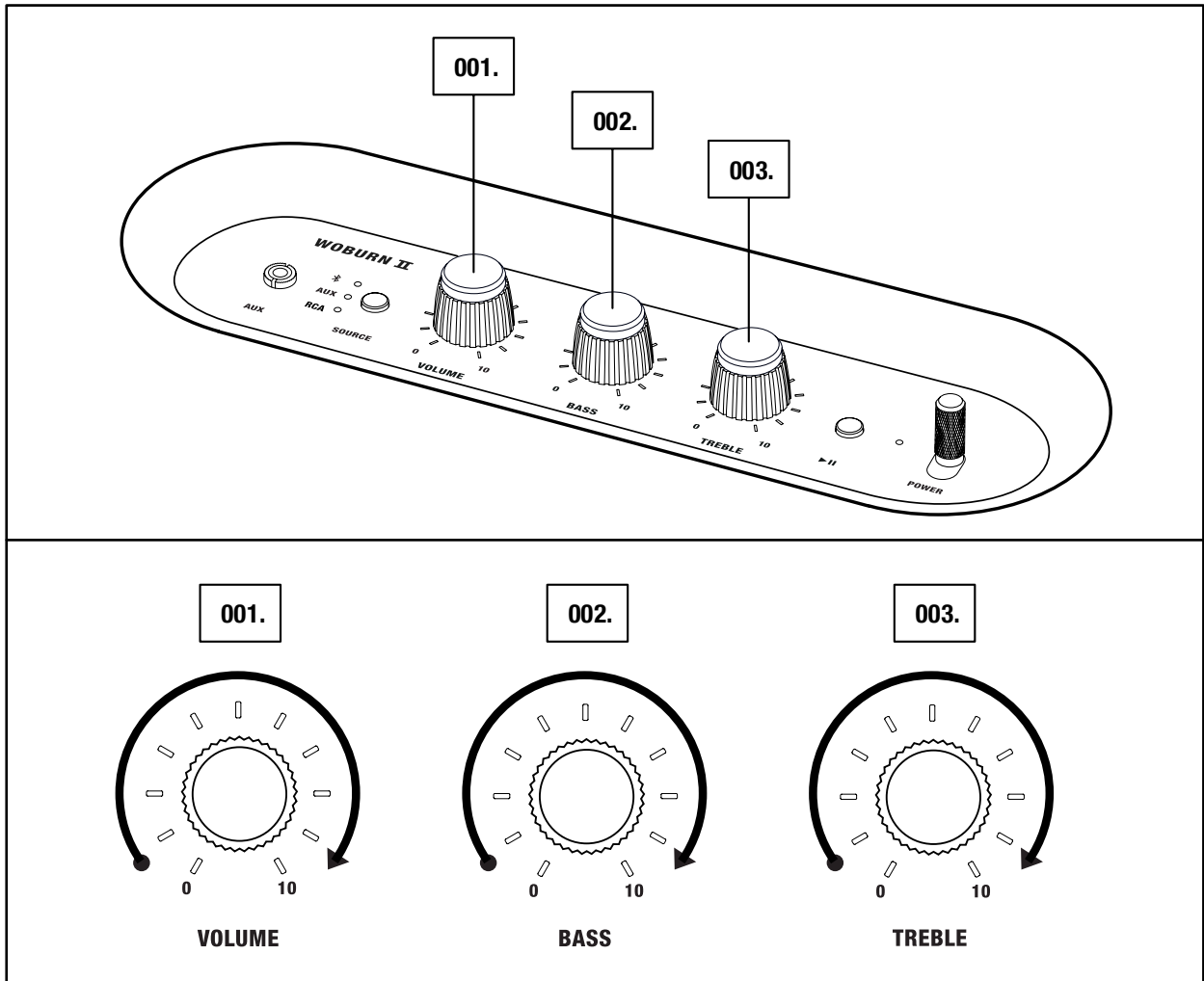

 NOTE: THE AUDIO CAN ALSO BE ADJUSTED FROM THE MARSHALL BLUETOOTH® APP.

PLAY/PAUSE CONTROL

THE WOBURN II HAS A PLAY/PAUSE BUTTON TO CONTROL THE MUSIC WHEN PLAYING VIA Bluetooth.

001. SINGLE-CLICK TO EITHER PLAY OR PAUSE.

002. DOUBLE-CLICK TO SKIP FORWARD.

003. TRIPLE-CLICK TO SKIP BACK.

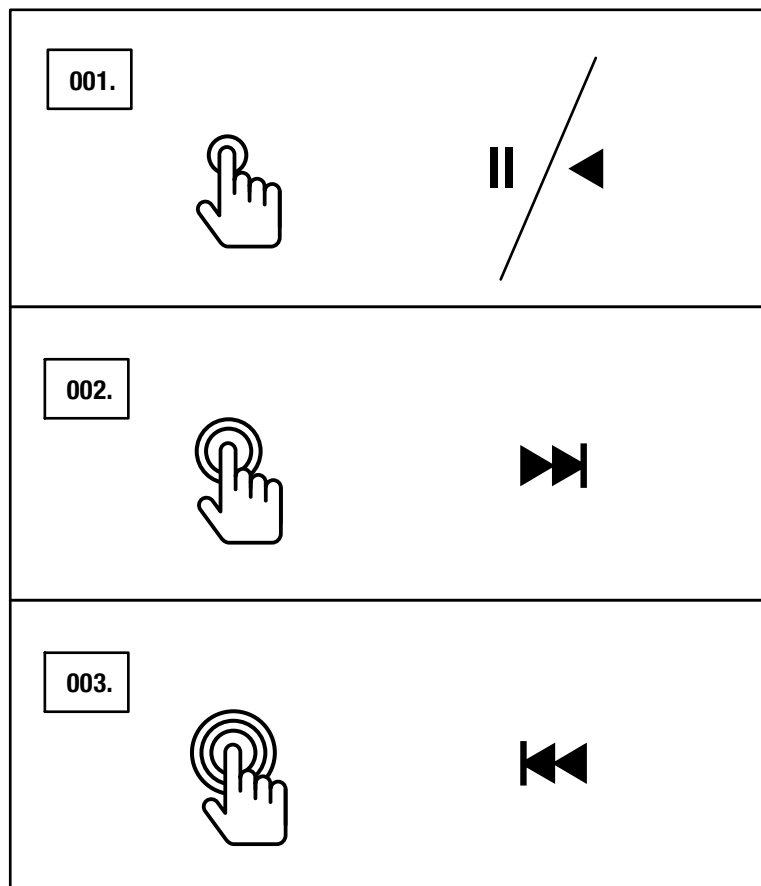

 NOTE: PLAYBACK CAN ALSO BE CONTROLLED FROM THE MARSHALL BLUETOOTH® APP.

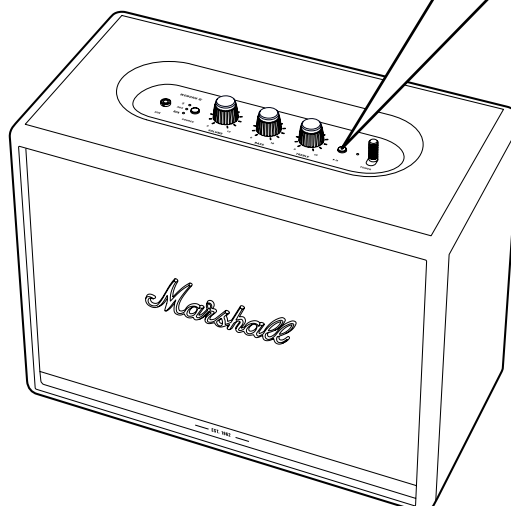

COUPLE SPEAKERS

TWO ACTON II, STANMORE II, OR WOBURN II SPEAKERS CAN BE COUPLED TO ACT AS ONE SOUND SYSTEM.

NOTE THAT CERTAIN HARDWARE COMPONENTS VARY BETWEEN MODELS, AND MAY CAUSE LIMITATIONS ON THE COUPLING SUPPORT. THE TABLE BELOW DISPLAYS THE COMPATIBILITY BETWEEN WOBURN II WITH OTHER MODELS.

THE SPEAKER MODEL IS STATED ON THE BACK OF THE SPEAKER.

WOBURN II BLUETOOTH

ACTON II	Yes
ACTON II BLUETOOTH	Yes
ACTON II BT	
STANMORE II	Yes
STANMORE II BLUETOOTH	Yes
STANMORE II BT	
WOBURN II BLUETOOTH	Yes

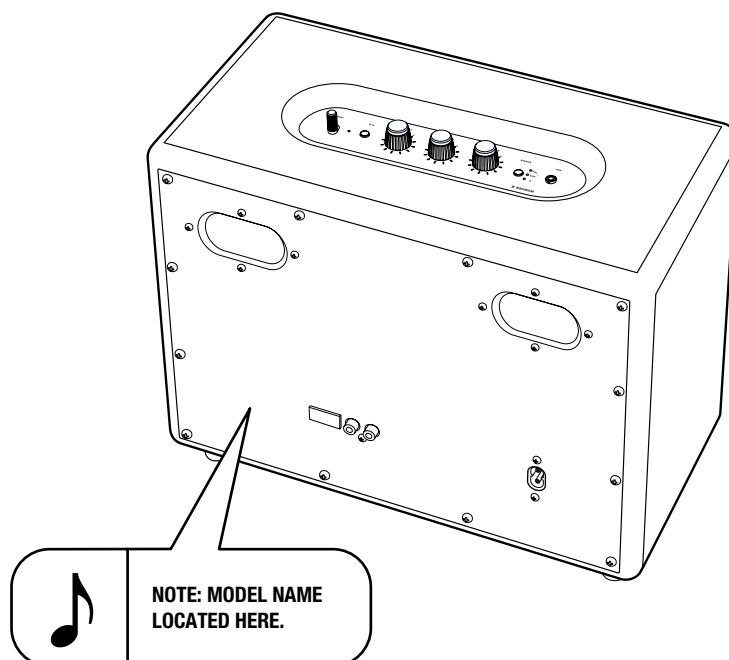

COUPLE SPEAKERS CONTINUED

THERE ARE TWO COUPLING MODES TO CHOOSE FROM:

- **AMBIENT MODE** - TWO SPEAKERS PLAY THE SAME AUDIO SYNCHRONISED. EACH SPEAKER PLAYS BOTH THE LEFT AND RIGHT CHANNELS. CHOOSE THIS MODE IF YOUR SPEAKERS ARE PLACED AT DIFFERENT HEIGHTS, DIRECTION OR AREAS OF THE ROOM.
- **STEREO MODE** - TWO SPEAKERS OF THE SAME SIZE ARE COUPLED AS A STEREO PAIR. WITH ONE SPEAKER THE LEFT CHANNEL AND THE OTHER THE RIGHT. CHOOSE THIS MODE IF THE SPEAKERS ARE PLACED AT THE SAME HEIGHT, EQUAL DISTANCE AND FACING THE SAME DIRECTION.

001. TO COUPLE TWO SPEAKERS, OPEN THE **MARSHALL BLUETOOTH®** APP AND CONNECT TO YOUR SPEAKERS.

002. GO TO **COUPLE SPEAKERS** AND FOLLOW THE IN-APP INSTRUCTION.

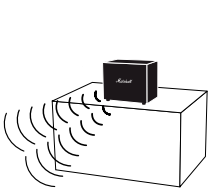

AMBIENT MODE

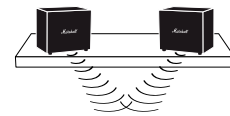
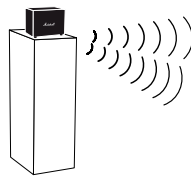

STEREO MODE

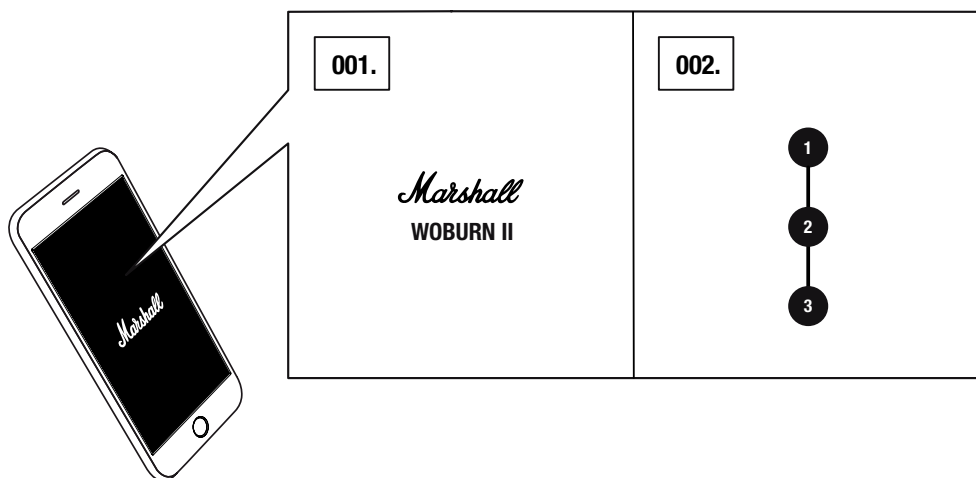

NOTE: MAKE SURE YOUR AUDIO DEVICE IS ONLY CONNECTED VIA Bluetooth TO ONE SPEAKER WHEN PLAYING ON COUPLED SPEAKERS.

STANDBY MODE

IF THE WOBURN II IS LEFT UNUSED FOR 20 MINUTES THE SPEAKER GOES INTO STANDBY TO SAVE ENERGY. IN THIS MODE ALL INDICATORS ARE OFF.

001. INTERACT WITH ANY BUTTON OR KNOB ON THE TOP PANEL TO WAKE THE SPEAKER UP FROM STANDBY MODE.

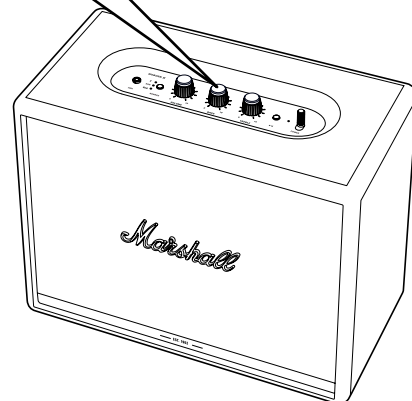
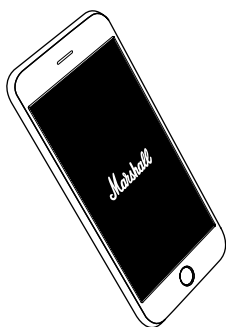
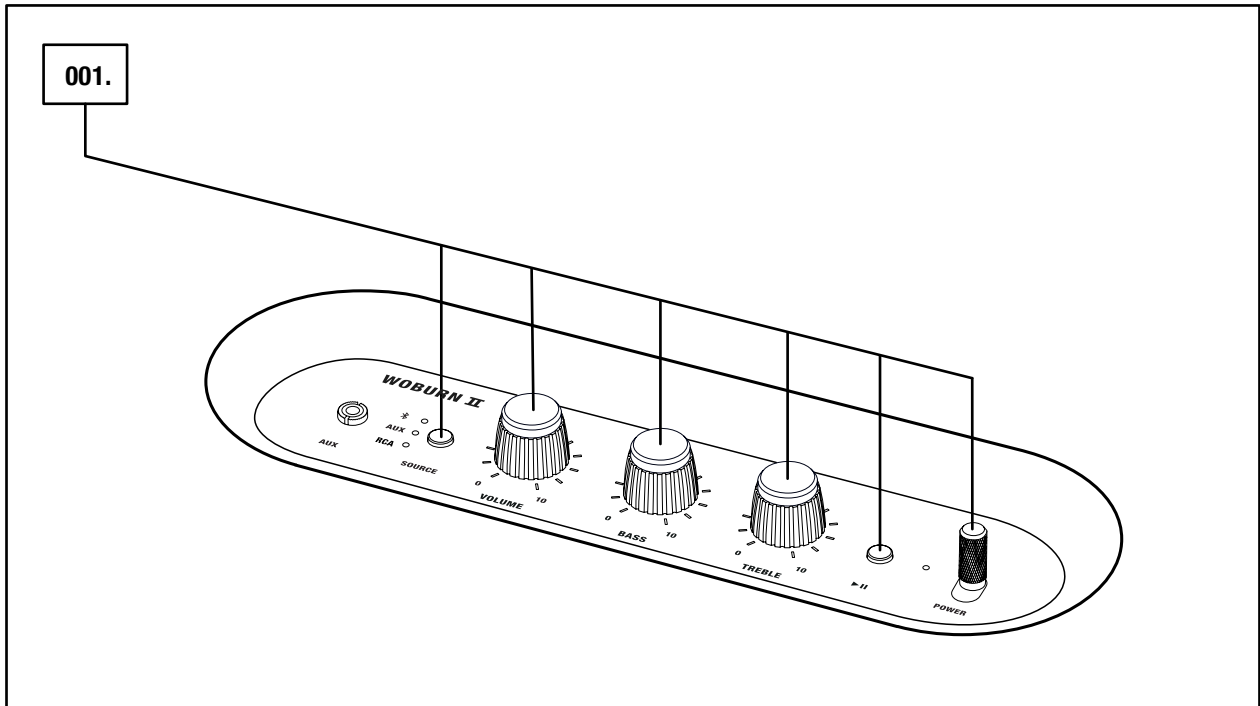

NOTE: THE SPEAKER CAN ALSO BE WOKEN FROM THE MARSHALL BLUETOOTH® APP.

TECHNICAL INFORMATION

ACOUSTIC SPECIFICATION

- **STEREO LOUDSPEAKER WITH BASS REFLEX SYSTEM**
- **DIGITAL CLASS D AMPLIFIERS:** 2 x 15 W + 2 x 50 W
- **TWEETERS:** 2 x ¾" dome tweeters
- **WOOFER:** 2 x 5¼" woofer
- **BASS AND TREBLE TONE CONTROLS**
- **FREQUENCY RESPONSE:** 30–20,000 Hz ±6 dB
- **MAXIMUM SOUND PRESSURE LEVEL:** 110 dB SPL @ 1 m

CONNECTIVITY

- **Bluetooth®:** Bluetooth 5.0 with Qualcomm® aptX™
- **AUX:** 3.5 mm stereo jack
- **RCA:** RCA (left and right)

TECHNICAL INFORMATION

- **MAINS INPUT VOLTAGE:** 100–240 VAC
- **MAINS FREQUENCY:** 50–60 Hz
- **SIZE:** 400 x 310 x 200 mm
- **WEIGHT:** 8.55 kg

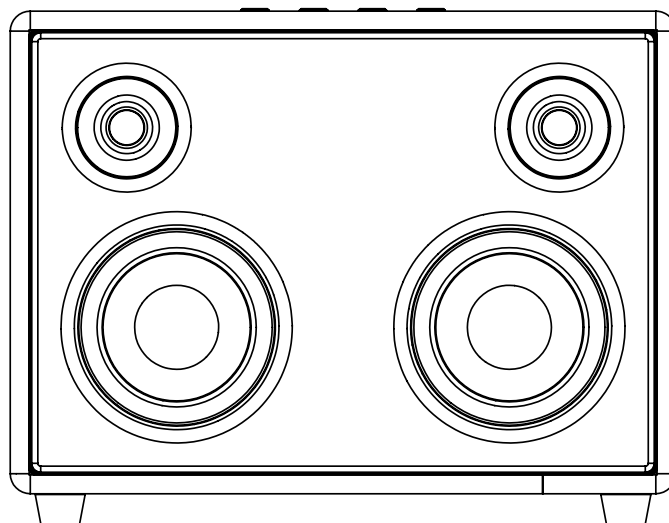

NOTE: THE FRONT OF THE SPEAKER IS NOT REMOVABLE. THIS ILLUSTRATION INTENDS TO SHOW THE INTERNAL SPEAKER LAYOUT. DO NOT ATTEMPT TO REMOVE THE FRET FOR RISK OF DAMAGING YOUR SPEAKER.

TROUBLESHOOTING

PROBLEM	CAUSE	ACTION
THE WOBURN II DOES NOT TURN ON	The speaker is not connected to mains electricity supply.	Connect the mains lead to the Woburn II and a working wall socket. Pull and hold the power lever towards the front of the speaker until the indicators light up.
THERE IS NO AUDIO OR AUDIO IS TOO LOW	The wrong sound source is selected.	Ensure that the device is connected to the Woburn II.
	Volume is set too low on either the audio source or the speaker.	Slightly increase the volume on your audio source or the speaker.
CANNOT CONNECT OR PAIR WITH A Bluetooth DEVICE	Bluetooth is not enabled on your device (smartphone, tablet, computer).	Activate Bluetooth on your device.
	There are already two devices connected to the speaker.	Disconnect one of the connected Bluetooth devices before connecting to the speaker.
	The speaker is not in pairing mode.	Push and hold the Bluetooth button for 3 seconds to make the speaker discoverable by the device.

TROUBLESHOOTING

PROBLEM	CAUSE	ACTION
THE SPEAKER IS NOT RESPONDING	A software problem has occurred.	Unplug the mains power plug from the wall socket, wait for 15 seconds, then plug it in again.
Bluetooth CONNECTION DROPS OUT	The two Bluetooth devices are too far apart or the connection is affected due to obstacles.	Move the devices closer so that they are within 10 metres, and unobstructed by obstacles such as walls or doors.
	There is a strong electric field surrounding the Woburn II.	Items such as microwave ovens, wireless network adapters, fluorescent lights and gas cookers use the same frequency range as the Bluetooth device. This may lead to electrical disturbances.
THERE IS A CRACKLING SOUND	The amplifier is clipping as it has run out of output power.	Decrease the volume on your audio source.
		Lower the volume or bass on the Woburn II.

TROUBLESHOOTING

PROBLEM	CAUSE	ACTION
THE AUDIO IS DISTORTED	Volume is set too high on the audio source.	Turn down the playback volume on the audio source.
	The audio stream or audio file is of poor quality.	Try another audio file or music player.
	Volume is set too high on the Woburn II.	Lower the volume on the speaker.
	Too much bass/treble on the speaker.	Lower the bass/treble on the speaker.
ERRATIC PERFORMANCE	Interference from another electronic device.	Move the Woburn II to another spot.
		Turn off or move the interfering electronic device.



NOTES:

A BLUETOOTH DEVICE COULD CAUSE AUDIO-RELATED OR TECHNICAL FAULTS, DEPENDING ON USE, IN THE FOLLOWING CASES:

- WHEN SOME PART OF THE BODY IS IN CONTACT WITH THE RECEIVING/TRANSMITTING SYSTEM FOR THE BLUETOOTH DEVICE OR THE WOBURN II.
- ELECTRICAL VARIATIONS DUE TO OBSTACLES IN THE FORM OF WALLS, CORNERS, ETC.
- EXPOSURE TO ELECTRICAL DISRUPTIONS FROM DEVICES WITHIN THE SAME FREQUENCY BAND, FOR EXAMPLE MEDICAL EQUIPMENT, MICROWAVE OVENS AND WIRELESS NETWORKS.

THIS WIRELESS DEVICE MAY CAUSE ELECTRICAL DISRUPTIONS DURING USE.

WWW.MARSHALLHEADPHONES.COM